



## Section 8 - Repair Parts List



### 8.1 Wheels and Casters

**PT Transport** For models: SP50-175PT

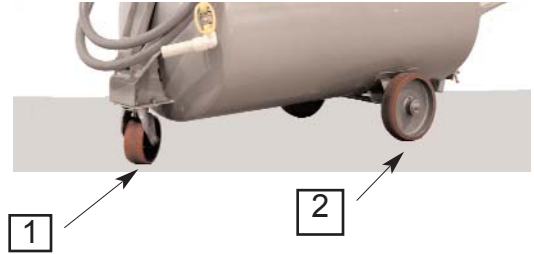
1		<b>SP-365</b>	Caster-Swivel 8" x 3" TRB-Poly
2		<b>SP-553</b>	Wheel, 12" x 3" Poly, TRB



**PL6 Transport** For models SP50-175PL6

1		<b>SP-297</b>	Caster-Swivel 8" RB-Phenolic
2		<b>SP-298</b>	Caster-Rigid 8" RB-Phenolic
3		<b>SP-531</b>	Wheel Brakes

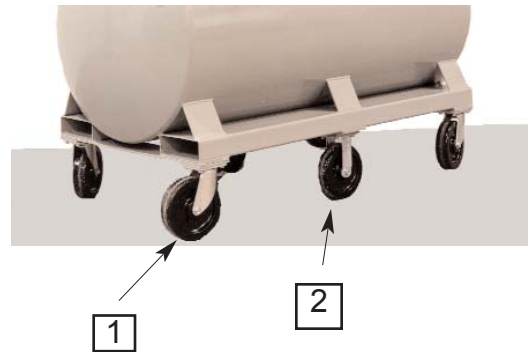

**PM Transport** For models SP50-175PM

1		<b>SP-366</b>	Wheel, 12" x 3" Poly, TRB
---	---	---------------	---------------------------

**TW Transport** For models SP50-175TW

1		<b>SP-270</b>	Caster-Swivel 12" x 3" MO, RT, RB
2		<b>SP-270-1</b>	Wheel, 12" x 3" Rubber, Roller Bearing, 3 1/2" Hub Length, 1" Axle
3		<b>SP-270-2</b>	Wheel, 16" x 3" Rubber, Roller Bearing, 3 1/4" Hub Length, 1" Axle

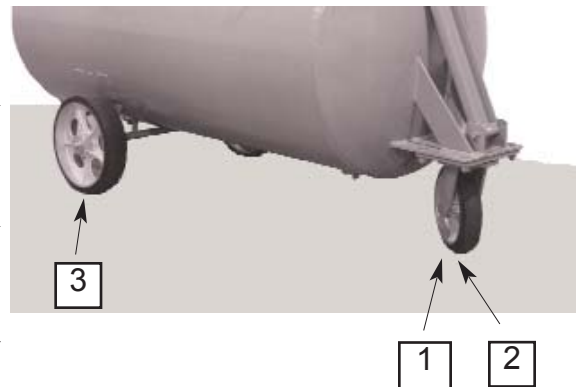

SP50 Propane Sumpcleaner/Filter



## 8.2 SP50 PUMP

For models: SP50-175PT  
SP50-175PL6  
SP50-175PM

SP50-175TW  
SP50-175PTL  
SP50-175CB

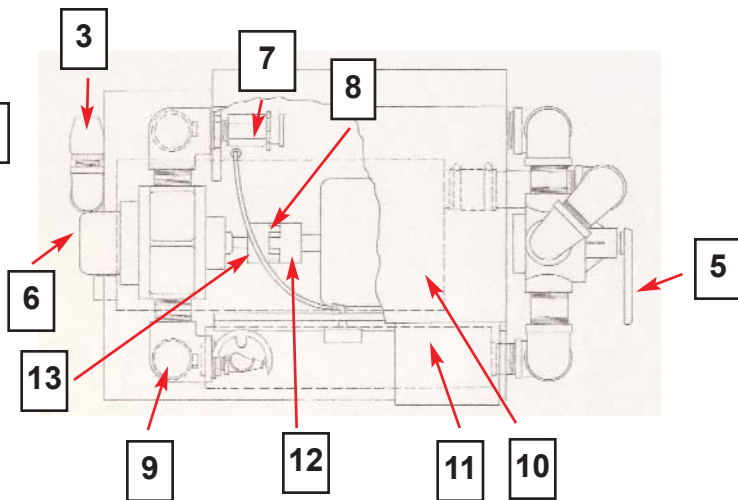
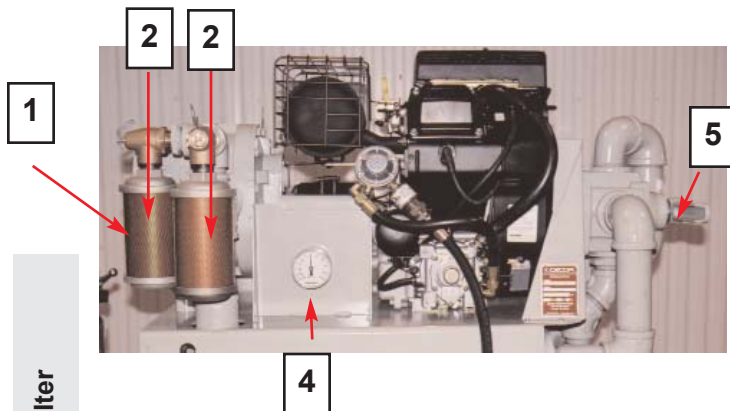

SP50 Propane Sumpcleaner/Filter

1	SP-442	Muffer, 1", 410		8	SP-529	Flexible Coupling Spider	
2	SP-443	Pressure Relief Valve, 1", 7 psi		9	A220-277	Flexible Coupling, 2" Pipe	<i>Not Pictured</i>
3	SP-446	Pressure Relief Valve, 1-1/4" x 1-1/2", 8 psi		10	SP-441	Muffer, 22070	
4	SP-195	Vacuum Pressure Gauge, 2-1/2" Back Mount		11	SP-394	Muffer, U5-1-1/2	
5	SP-444	4-Way Valve, 2"		12	SP-515	Flexible Coupling Body, 1"	
6	SP-388	Vacuum Pump, 3MVF		13	SP-528	Bore Flexible Coupling Body, 3/4" Bore	
7	SP-506	Vacuum Relief Valve, 1"		14	A210-148	Float Control Assembly (2 balls), 1-1/4"	

### 8.3 TANK COMPONENTS

SP50-175PT  
 SP50-175PL6  
 SP50-175PM

SP50-175TW  
 SP50-175PTL  
 SP50-175CB

SP50 Propane Sumpcleaner/Filter

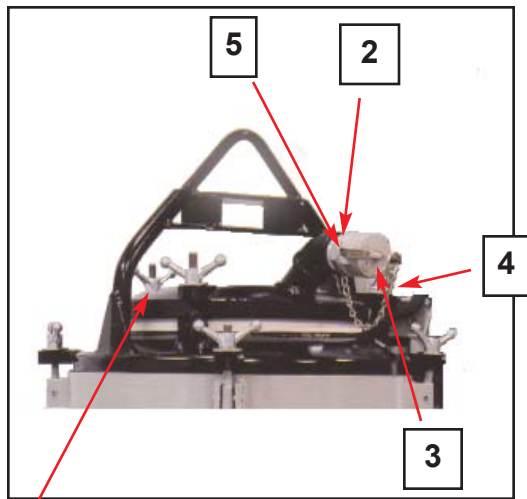

9

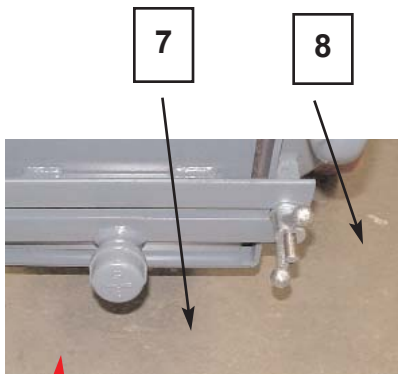

1

1		SP-104	Wing Nut – 1/2-13
2		SP-375	Adapter, Disconnect, 2" Male Threads, F
3		SP-374	Disconnect Cap – 2", V
4		SP-373	Security chain with small hooks
5		SP-262BN-2	Coupler, Gasket, 2"
6	<i>Not pictured</i>	A-220-495	Hood, SP50
7		A-220-240	Cleanout Door Assembly
8		A-210-165	Cleanout Door Gasket
9		SP-386	Wing Nut 5/8-11





## 8.4 FILTER COMPONENTS

FOR MODELS: SP50-175PT SP50-175TW  
 SP50-175PL6 SP50-175PTL  
 SP50-175PM SP50-175CB

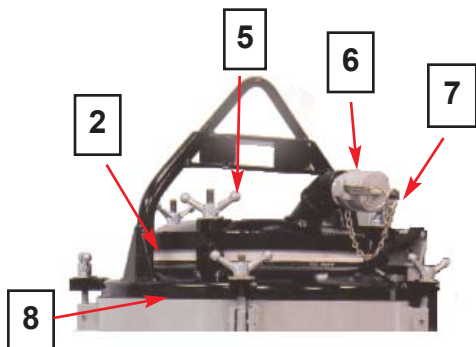
SP50 Propane Sumpcleaner/Filter

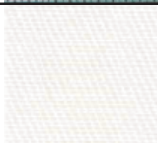

1	<i>Not pictured</i>	A-220-275	Filter Lid Assembly, F50
2		A-220-274	Filter Lid Gasket F50
3		A220-336	Filter Sleeve, 5 cubic feet, Polypropylene F50
4		A220-583	Filter Sleeve, 5 cubic feet, Fine F50







5		SP-386	Wing Nut, 5/8-11
6		SP-375	Disconnect Adapter, 2" Male Threads
7		SP-373	6" Security Chain
8		A220-276	Pot Lid Gasket



**8.5****TOOLS & ACCESSORIES**

FOR MODELS:

SP50-175PT  
SP50-175PL6  
SP50-175PMSP50-175TW  
SP50-175PTL  
SP50-175CB

1		A-220-151	Nozzle Assembly, Flare, Fits 2" hose
2		A-210-965	Nozzle, Straight, Fits 2" hose
3		A-220-152	Nozzle Assembly, Fits 2" hose
4		A-220-147R	Sumpcleaner Hose, 2" x 16', Red
5	<i>Not Pictured</i>	A-220-148R	Hose Assembly, Extender
6	<i>Not Pictured</i>	A220-624	Floor Squeegee for 2" Hose
7		A-220-145	Dispensing Hose
8		A220-562	Nozzle Valve Assembly

