

Easy-Loading Container for Low Clearances

- Low side for easy loading. Fits easily under machine tool discharge and other low-clearance plant equipment. Helps eliminate mess around expensive machine tools.
- Heavy-duty steel construction with fully welded seams that don't leak, melt, split, bulge or burn.
- Smart design maximizes cube capacity while minimizing footprint thereby preserving valuable floor space.
- Maneuvers easily and rolls smoothly, even when loaded.
- Features conveniently placed push handles.
- Pair with CECOR Dumping Frame (sold separately) for elevated, rotational dumping. Dump heavy loads easily.
- Proudly designed and manufactured in the U.S.A.

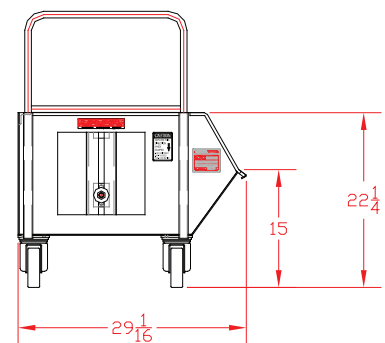

Specification:	044 Series
Capacity:	9.6 cubic feet
Load Rating:	1,000 lbs.
Bin Dimensions:	42" long x 28" wide x 15 1/2" deep
Lip Height:	15"
Dumping Methods:	DB = rotational dumping* RB = hydraulic dumping** WB = both rotational & hydraulic FB = fork pocket dumping***
Dumping Frame:	DF-1044
Color:	Black standard, gray optional
Wheels:	5-inch phenolic****
Add'l Options:	Drain plug Hinged drain cover Four swivel casters <i>Inquire about other special options.</i>
Shipping Weight:	154 lbs.

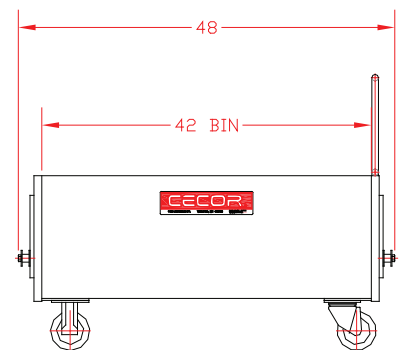

*For use with CECOR Dumping Frame.
**For use with hydraulic dumping system.
***For use with rotatable fork system. May require modifications.
****Other sizes and styles available.